

DL1600M

Generator Set for Drilling Applications

Land Rig SCR Power

- Designed and built to meet the demanding requirements of the drilling contractor

High Reliability

- Rugged design
- Easy maintenance
- Long service life

Low Operating Cost

- High fuel efficiency
- Long service intervals

Meets Most International Specifications

Standard Equipment

- EPA Tier 2 non-road certified
- Electronic engine controls
- Generator space heater
- Stator RTDs
- Heavy duty, structural steel base
- Lifting provisions
- Fuel supply/return connections
- Air starting system
- Batteries, 12V lead calcium (2)
- Battery boxes, polyethylene (2)
- Generator, two-bearing design
- Dry type air filter, heavy duty
- Service indicator
- Air intake shutoff valve
- Radiator, 122°F (50°C)
- Blower fan, engine belt driven
- Lube oil filters
- Engine mounted oil cooler
- Fuel filters, primary & secondary
- Control Panel, unit-mounted

- Shutdowns and Alarms
 - High Jacket Water Temperature
 - Low Oil Pressure
 - High Oil Temperature
 - Engine Over Speed
- Engine hourmeter
- Start/Stop controls
- Emergency Stop switch

Options

- Generator air filters
- Bearing RTD (1 per)
- Electric starter 24 VDC
- Dual air/electric starting system
- Exhaust Silencers
- Rain caps
- Exhaust flexible connections, SS
- Radiator, 131°F (55°C)
- Remote cooling package
- Copon coating
- Lube oil heating system
- Duplex fuel filters
- Fuel/water separator
- Control Panel, remote-mounted



See Back For Product Specifications ▶ ▶ ▶ ▶



A Century of Innovation

DL1600M SCR Generator Set

RATINGS	
Drilling (prime) kWe/kVA rating @ 60 Hz*	1633/2041
Rated Voltage	600/346 VAC
Rated Frequency	60 Hz
Rated Power Factor (lagging)	0.7

* At voltage, frequency and PF according to ISO 3046/1 conditions.

ENGINE	
Manufacturer	MTU
Model	16V4000
Type	4 cycle
Fuel	Diesel
Cylinders	V-16
Power output (hp)	2425
Speed (rated)	1800 rpm

GENERATOR	
Type	Brushless
Poles	6 pole
Stator	Form wound
Bearing	Dual, sealed
Insulation	Class H
Temperature rise @40 °C	80 °C
Voltage Regulation	DVR

DIMENSIONS	
Weight (approx.)	39,700 lbs
L x W x H (in inches)	280 x 102 x 121

All dimensions are in inches and are approximate. Air filters to be shipped loose, max dimensions shown.

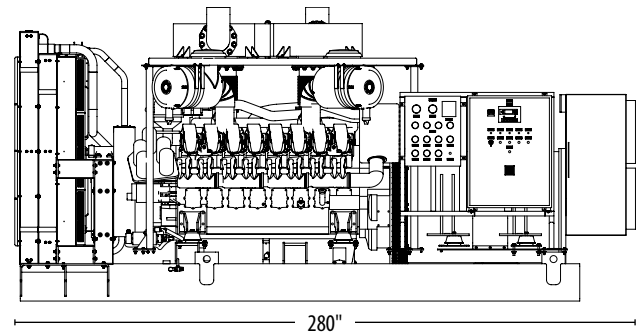
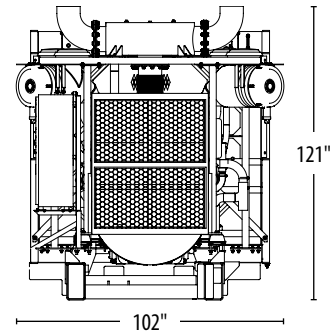

Contact us today.

Albuquerque, NM
+1 505-881-3511

Denver, CO
+1 303-287-7441

Houston, TX
+1 713-671-6220

Odessa, TX
+1 432-563-4800

Waco, TX
+1 254-857-4351

Amarillo, TX
+1 806-352-4717

El Paso, TX
+1 915-790-1848

Lafayette, LA
+1 337-837-9001

Pharr, TX
+1 956-787-6880

Wichita Falls, TX
+1 940-322-5227

Casper, WY
+1 307-234-6975

Farmington, NM
+1 505-325-5071

Longview, TX
+1 903-758-5562

Pueblo, CO
+1 719-543-7056

Corpus Christi, TX
+1 361-289-5350

Gillette, WY
+1 307-685-6413

Lubbock, TX
+1 806-745-4224

San Antonio, TX
+1 210-662-1000

Dallas, TX
+1 214-631-5370

Grand Junction, CO
+1 970-248-4100

New Orleans, LA
+1 504-347-4326

10-06-021 ©2010 Stewart & Stevenson Visit us at www.stewartandstevenson.com.

All data subject to change without notice. The information in this bulletin is believed to be accurate but all recommendations are made without warranty, since the conditions of use are beyond Stewart & Stevenson's control. Stewart & Stevenson disclaims any liability in connection with the use of this information, and does not warrant against infringement by reason of the use of any of its products in combination with other material or in any process. Stewart & Stevenson warrants only that the product complies with specifications agreed to in contracts of sale.



A Century of Innovation